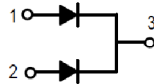

Silicon Schottky Diode, 120A

Features

- Guard Ring Protection
- Low forward voltage drop
- High surge current capability
- Up to 100V V_{RRM}

TWIN TOWER PACKAGE

Maximum Ratings ($T_J = 25^\circ\text{C}$ unless otherwise specified)

Parameter	Symbol	Conditions	MBR12045CT (R)	MBR12060CT (R)	MBR12080CT (R)	MBR120100C T(R)	Units
Repetitive peak reverse voltage	V_{RRM}		45	60	80	100	V
RMS reverse voltage	V_{RMS}		32	42	56	70	V
DC blocking voltage	V_{DC}		45	60	80	100	V
Average forward current	$I_{F(AV)}$	$T_C \leq 140^\circ\text{C}$	120	120	120	120	A
Non-repetitive forward surge current, half sine-wave	I_{FSM}	$T_C = 25^\circ\text{C}$ $t_p = 8.3\text{ ms}$	800	800	800	800	A

Electrical Characteristics ($T_J = 25^\circ\text{C}$ unless otherwise specified)

Parameter	Symbol	Conditions	MBR12045CT (R)	MBR12060CT (R)	MBR12080CT (R)	MBR120100C T(R)	Units
DC forward voltage	V_F	$I_F = 60\text{ A}$ $T_J = 25^\circ\text{C}$	0.68	0.75	0.86	0.86	V
DC reverse current	I_R	$V_R = 20\text{ V}$ $T_J = 25^\circ\text{C}$	3	3	3	3	mA
		$V_R = 20\text{ V}$ $T_J = 125^\circ\text{C}$	200	200	200	200	

Thermal Characteristics ($T_J = 25^\circ\text{C}$ unless otherwise specified)

Parameter	Symbol		MBR12045CT (R)	MBR12060CT (R)	MBR12080CT (R)	MBR120100C T(R)	Units
Thermal resistance junction to case	R_{thj-c}		0.8	0.8	0.8	0.8	$^\circ\text{C}/\text{W}$
Operating, storage temperature range	T_J, T_{stg}		- 40 to +175	- 40 to +175	- 40 to +175	- 40 to +175	$^\circ\text{C}$

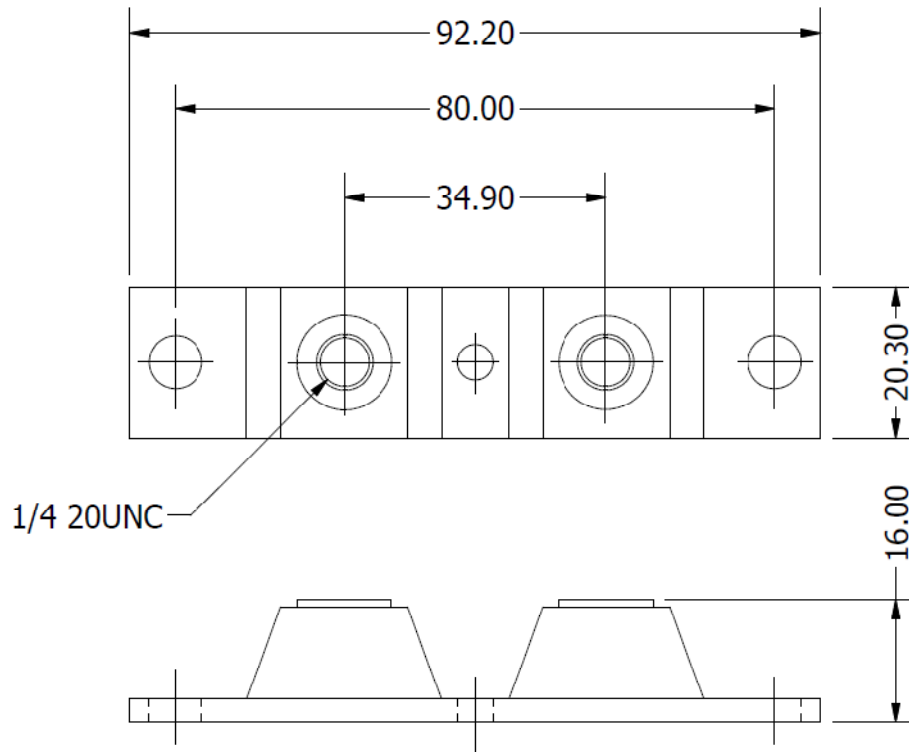
Package Outline

ALL DIMENSIONS IN MM

Ordering Table

<i>MBR</i>	<i>120</i>	<i>45</i>	<i>CT</i>
1	2	3	4

- 1 – Device Type
 - > MBR = Schottky Barrier Diode Module
- 2 – Current Rating = $I_{F(AV)}$
- 3 – Voltage = code x 10 = V_{RRM}
- 4 – Polarity
 - > CT = Normal (Cathode to Base)
 - > CTR = Reverse (Anode to Base)