

Super Fast Recovery Diode, 50A

Features

- Glass passivated die
- Low forward voltage drop
- High surge capability
- Low leakage current
- Normal and Reverse polarity
- Metric and UNF threads available



DO-203AB (DO-5)

Maximum Ratings ($T_J = 25^\circ\text{C}$, unless otherwise noted)					
Parameter	Test Conditions	Symbol	MUR5040(R)	MUR5060(R)	Units
Repetitive peak reverse voltage		V_{RRM}	400	600	V
RMS reverse voltage		V_{RMS}	280	420	V
DC blocking voltage		V_{DC}	400	600	V
Continuous forward current	$T_C \leq 125^\circ\text{C}$	$I_{F(AV)}$	50	50	A
Surge non-repetitive forward current, half-sine wave	$T_C = 25^\circ\text{C}$	I_{FSM}	600	600	A
Maximum peak forward voltage	$I_F = 50\text{ A}, T_J = 25^\circ\text{C}$	V_F	1.3	1.7	V
Reverse current	$T_J = 25^\circ\text{C}$	I_R	10	10	μA
	$T_J = 125^\circ\text{C}$		3	3	mA
Maximum reverse recovery time	$I_F = 0.5\text{ A}, I_R = 1.0\text{ A}$	t_{rr}	75	90	ns

Thermal & Mechanical Specifications ($T_J = 25^\circ\text{C}$, unless otherwise noted)				
Parameters	Symbol	MUR5040(R)	MUR5060(R)	Units
Operating junction temperature range	T_J	-60 to 150	-60 to 150	$^\circ\text{C}$
Storage temperature	T_{stg}	-60 to 150	-60 to 150	$^\circ\text{C}$
Mounting torque, non-lubricated threads, tightening on nut	F	3.5 \pm 10%		Nm
Approximate weight	W	17		g

Package Outline

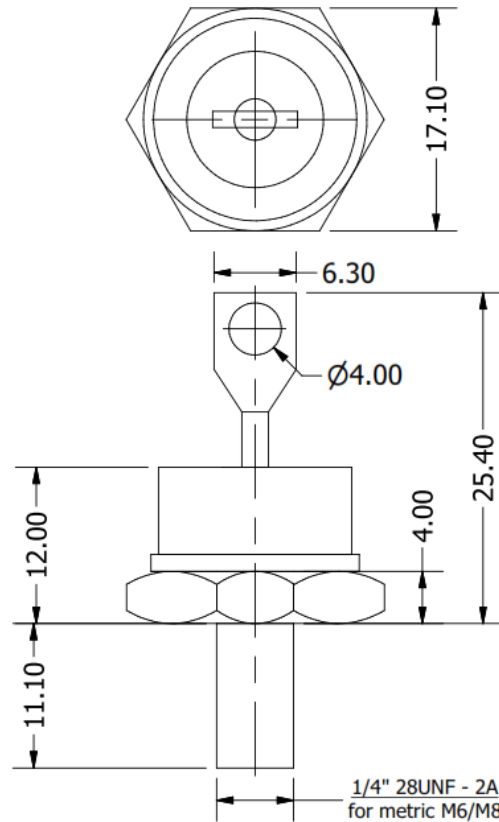
Dimensions for DO-203AB (DO-5) (in millimeters)



Ordering Table

MUR	50	40	R
1	2	3	4

- 1 – Device Type
 - > MUR = Super Fast Recovery Diode
- 2 – Current Rating = $I_{F(AV)}$
- 3 – Voltage x 10 = V_{RRM}
- 4 – Polarity
 - > None = Normal (Cathode to Stud)
 - > R = Reverse (Anode to Stud)